

## THE PULSE OF AUTOMATION

### PRODUCT OVERVIEW ULTRASONIC SENSORS



# Automation is our world. Perfect application solutions are

A willingness to take entrepreneurial risks, a pioneering spirit, and a firm belief in their own inventive powers – these were the assets that Walter Pepperl and Ludwig Fuchs started out with when they opened their Mannheim radio repair shop in 1945. Their invention of the proximity switch a few years later proved their strength. It was also the starting point in a successful history defined by close customer relationships as well as innovative automation technologies and procedures.

Then as now, our focus is squarely on the individual requirements of each customer. Whether as a pioneer in electrical explosion protection, or as a leading innovator of highly efficient sensors – the intensive communication with our customers is what allowed us to become the leader in automation technology.

Our main objective is combining state-of-the-art technologies and comprehensive services to optimize our customers' processes and applications. And when it comes to ultrasonic technology, the company has more than 20 years of experience. The own manufacturing department stands for consistently high sensor quality and guarantees a unique ultrasonic portfolio.

For more information about ultrasonic sensors, please visit our website: [www.pepperl-fuchs.com/ultrasonics](http://www.pepperl-fuchs.com/ultrasonics)

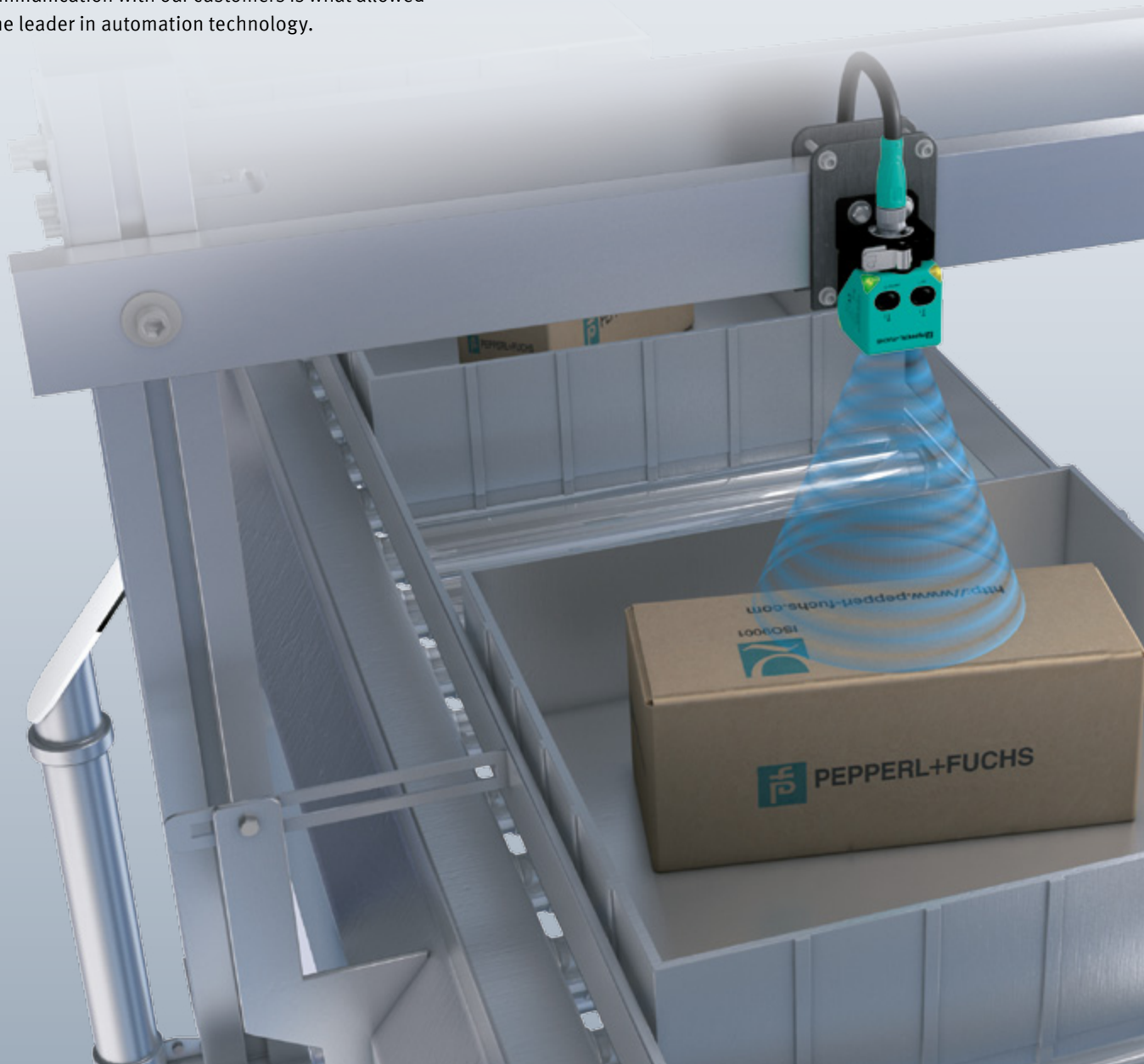

our goal.

# Content

<b>Cylindrical housings</b>	06
<b>Cube-style housings</b>	08
<b>VariKont Series</b>	09
<b>Special ultrasonic sensors</b>	10
<b>Accessories</b>	12
<b>Software</b>	13

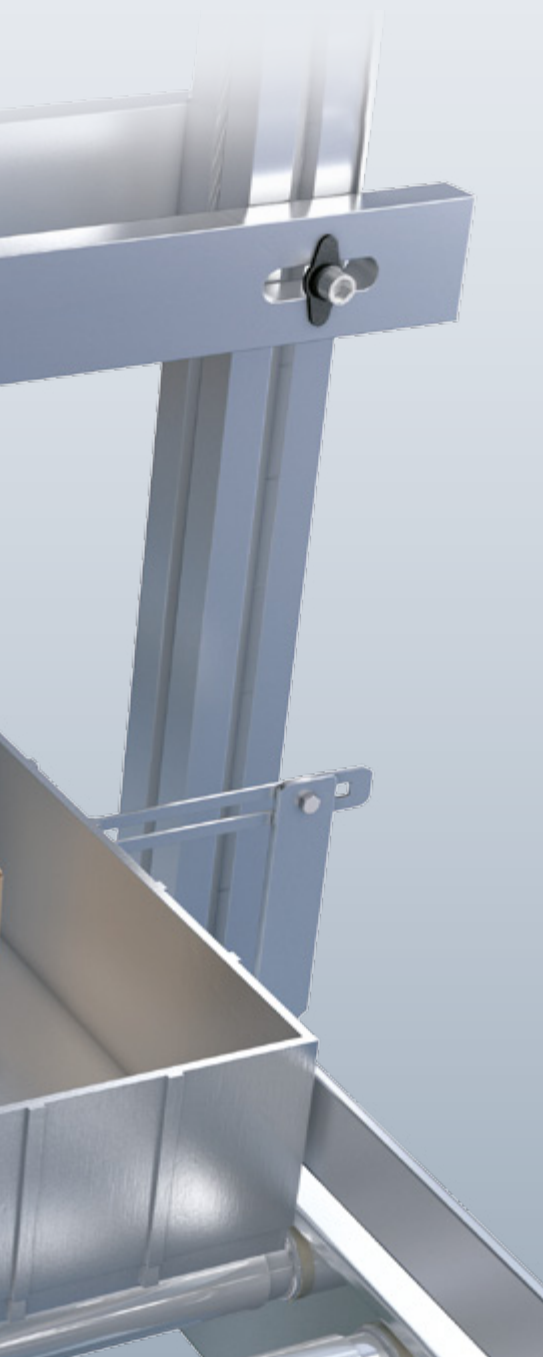

# The pulse of automation

When it comes to automatically controlled manufacturing systems, sensors determine the pulse of all operations. They detect objects, activate process sequences, and help to enable safe and controlled manufacturing processes.

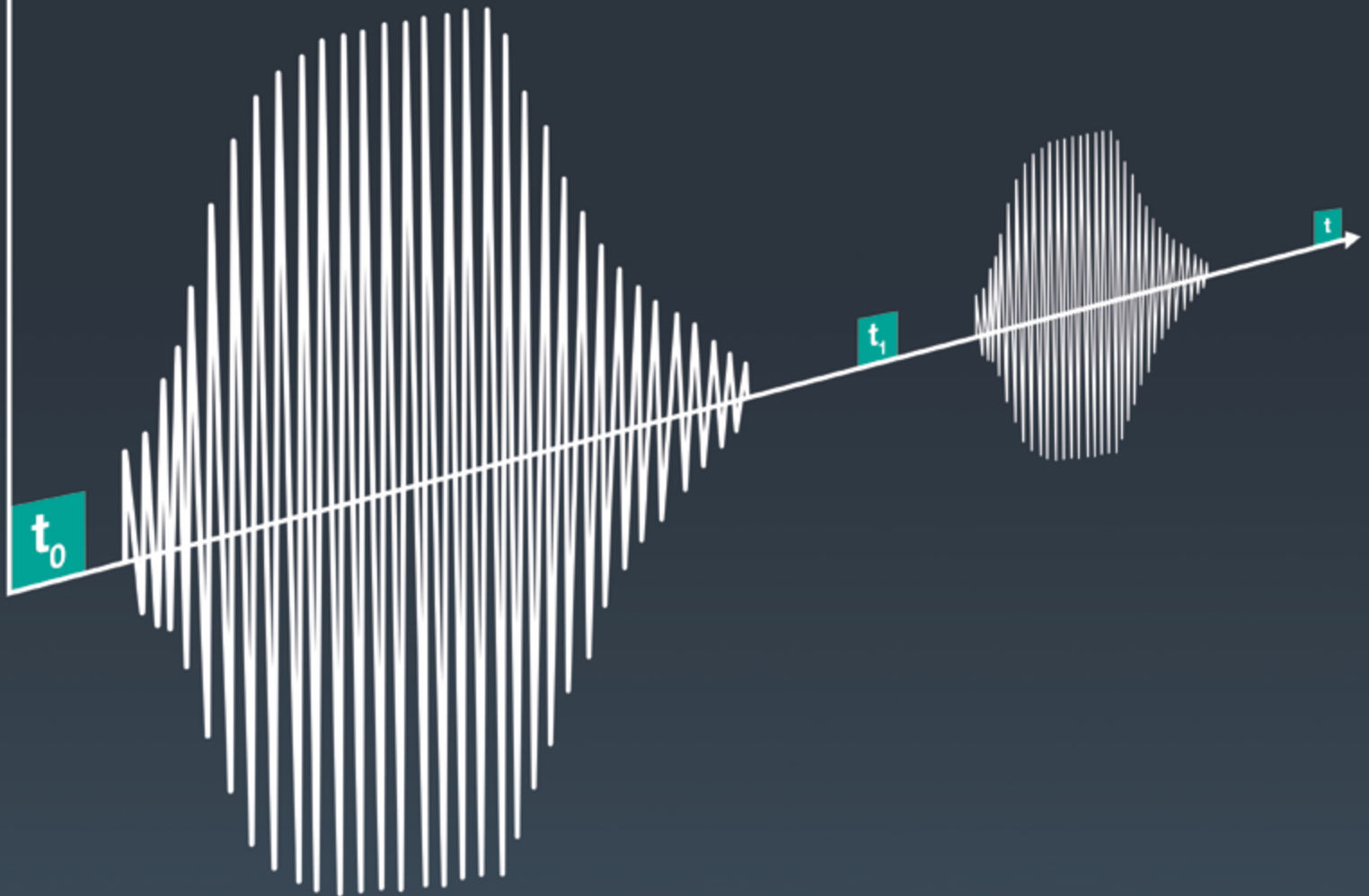

Among this family, ultrasonic sensors have developed into universal solutions that cover a wide range of applications, offering reliable operation in environments where traditional sensing technologies are unsuitable. They detect objects with utmost precision, operate in harsh and problematic environments, and are unaffected by target shape or color.

The latest generation of ultrasonic sensors from Pepperl+Fuchs provides advantages such as an optimized dead band and simple, intuitive installation.

Three new sensor families cover the complete application spectrum. The compact F77 sensors provide best-in-class immunity to acoustic interference and are designed for space-restrictive installations. UC...30GM70 sensors feature a detachable infrared interface for easy software configuration. The UC...30GM...IO sensors are easily configured via push-button or IO-Link, and solve a wide range of applications. Backed by decades of experience and technical leadership, Pepperl+Fuchs leads the industry in innovation, reliability, and product diversity.

# Function types

The ultrasonic sensors can detect objects made from a wide variety of materials with millimeter precision, regardless of shape and color. The sensor uses extremely high-frequency sonic pulses inaudible to the human ear to transmit information.

The ultrasonic sensor principle of measurement is based on the calculation of the time elapsed between sound wave transmission and reception (probe mode) or whether the transmitted signal is received or not (barrier mode).

## BARRIER MODE

### ■ Thru-beam sensor

Emitter and receiver are installed facing one another. If the ultrasonic signal path is interrupted by an object, the switch output is activated.

Advantage: Long sensing range

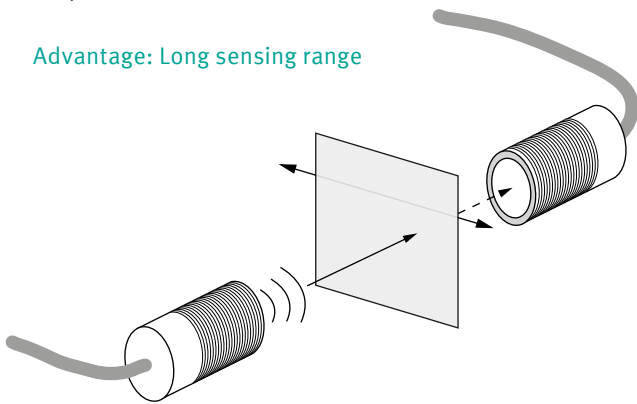

## PROBE MODE

- Emitter and receiver are located in the same housing. The ultrasound is reflected directly back to the receiver from the object to be detected.

Advantage: Simple, compact sensor, most commonly used principle.

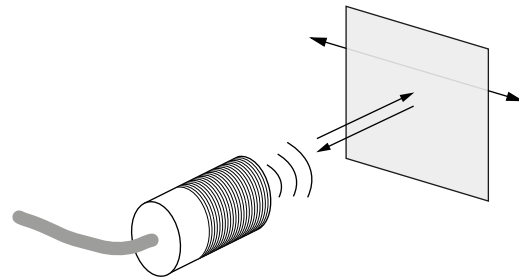

### ■ Retroreflective barrier

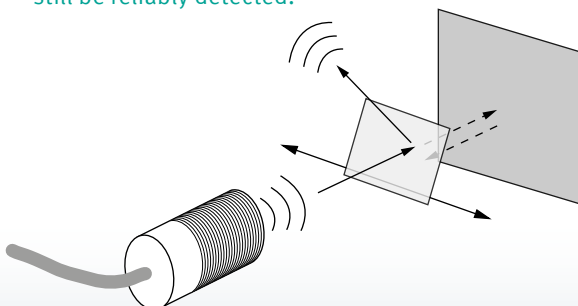

Emitter and receiver are located in the same housing. The ultrasound is reflected from a previously defined reflector back to the receiver.

Advantage: Nonreflective or weakly reflected objects can still be reliably detected.

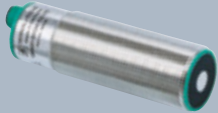
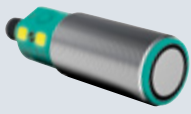

# Cylindrical housings

Housing style	Main features	Model number	Sensing range	Switching output	Analog output	Interface	Setting
<b>UB-12GM</b> ø 12 mm x 70 mm 	<ul style="list-style-type: none"> <li>Compact housing</li> <li>Small blind zone</li> <li>Short response time</li> <li>Temperature compensation</li> </ul>	UB120-12GM UB200-12GM UBC250-12GM UB400-12GM	120 mm 200 mm 250 mm 400 mm	1NC/1NO	■	–	Teach-in input
<b>UBH-12GM</b> ø 12 mm x 70 mm 	<ul style="list-style-type: none"> <li>Compact housing</li> <li>Small blind zone</li> <li>Short response time</li> <li>Temperature compensation</li> <li>Very high resolution</li> </ul>	UBH60/30-12GM	60 mm	1NC/1NO	■	–	Teach-in input
<b>18GM40</b> ø 18 mm x 40 mm 	<ul style="list-style-type: none"> <li>Compact design</li> <li>Highly visible function display</li> <li>Teach-in</li> <li>Temperature compensation</li> </ul>	UB300-18GM40(A) UB800-18GM40(A) UBC400-18GH40 UBE1000-18GM40	300 mm 800 mm 400 mm 1000 mm	1NC/NO	■	–	Teach-in input
<b>UB-18GM75</b> ø 18 mm x 75 mm 	<ul style="list-style-type: none"> <li>Selectable beam width</li> <li>Teach-in</li> <li>Synchronization option</li> </ul>	UB500-18GM75 UB1000-18GM75	500 mm 1000 mm	1NC/NO 2NC/NO	■	–	Teach-in input
<b>18GM90</b> ø 18 mm x 90 mm  	<ul style="list-style-type: none"> <li>IO-Link interface for service and process data</li> <li>Switching output</li> <li>Temperature compensation</li> </ul>	UC1000-18GM90	1000 mm	1NC/NO	–	IO-Link	–

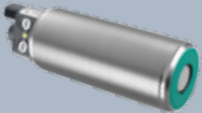

Housing style	Main features	Model number	Sensing range	Switching output	Analog output	Interface	Setting
<b>UB-30GM</b> ø 30 mm x 90/105/110 mm 	<ul style="list-style-type: none"> <li>Teach-in</li> <li>Temperature compensation</li> </ul>	UB500-30GM UB2000-30GM UB4000-30GM UB6000-30GM	500 mm 2000 mm 4000 mm 6000 mm	1NC/NO	–	–	Teach-in input
<b>UC-30GM</b> ø 30 mm x 90/105/110 mm 	<ul style="list-style-type: none"> <li>Parameterization interface</li> <li>Teach-in</li> <li>Temperature compensation</li> </ul>	UC300-30GM UC500-30GM UC1000-30GM UC2000-30GM UC4000-30GM UC6000-30GM	300 mm 500 mm 1000 mm 2000 mm 4000 mm 6000 mm	2NC/NO	■	RS232	ULTRA 3000 Teach-in connector
<b>UC-30GM-IO</b> ø 30 mm x 90 mm  	<ul style="list-style-type: none"> <li>IO-Link</li> <li>Basic parameterization using buttons</li> <li>Teach-in</li> <li>Temperature compensation</li> </ul>	UC500-30GM-...-IO UC2000-30GM-...-IO UC4000-30GM-...-IO UC6000-30GM-...-IO	500 mm 2000 mm 4000 mm 6000 mm	1NC/1NO 2NC/2NO	■	IO-Link	Button <b>PACTware™</b>
<b>UC-30GM70</b> ø 30 mm x 100/110/130 mm 	<ul style="list-style-type: none"> <li>Adjustment using potentiometer</li> <li>Real-time parameterization interface</li> <li>Temperature compensation</li> </ul>	UC500-30GM70 UC2000-30GM70 UC3500-30GM70 UC6000-30GM70	500 mm 2000 mm 3500 mm 6000 mm	2NC/NO	■	Infrared	Ultra-Prog-IR

# Cube-style housings

Housing style	Main features	Model number	Sensing range	Switching output	Analog output	Interface	Setting
<b>F77</b> 31 mm x 23 mm x 12 mm 	<ul style="list-style-type: none"> <li>Ultrasonic sensor in miniature housing</li> <li>Minimal blind zone</li> <li>Teach-in</li> <li>Reflection, retroreflection, thru-beam</li> </ul>	UB250-F77 UBR250-F77 UB400-F77 UBR400-F77 UBE800-F77	250 mm 250 mm 400 mm 400 mm 800 mm	1NC/1NO	Frequency output	–	Teach-in input
<b>F12</b> 49 mm x 42 mm x 15 mm 	<ul style="list-style-type: none"> <li>Adjustable beam width</li> <li>Teach-in</li> </ul>	UB120-F12 UB250-F12 UB800-F12	120 mm 250 mm 800 mm	1NC/NO	■	–	Potentiometer Button
<b>F43</b> 145 mm x 52 mm x 30 mm 	<ul style="list-style-type: none"> <li>Serial interface</li> <li>Relay outputs</li> <li>Temperature compensation</li> </ul>	UC300-F43 UC2000-F43	300 mm 2000 mm	Relay	■	RS232	ULTRA 3000
<b>F54</b> 120 mm x 32 mm x 25 mm 	<ul style="list-style-type: none"> <li>Teach-in</li> <li>Temperature compensation</li> </ul>	UB500-F54 UB2000-F54	500 mm 2000 mm	1NC/1NO	■	–	Teach-in input
<b>F42</b> 80 mm x 80 mm x 34 mm 	<ul style="list-style-type: none"> <li>Easy mounting</li> <li>Teach-in</li> <li>Relay output</li> </ul>	UB400-F42 UB500-F42 UB1500-F42 UB2000-F42 UB3000-F42 UB4000-F42 UB5000-F42 UB6000-F42	400 mm 500 mm 1500 mm 2000 mm 3000 mm 4000 mm 5000 mm 6000 mm	Relay 1NC/NO 2NC/NO	■	–	Teach-in input



# VariKont Series

Housing style	Main features	Model number	Sensing range	Switching output	Analog output	Interface	Setting
<b>VariKont</b> 131 mm x 30 mm x 30 mm 	<ul style="list-style-type: none"> <li>Serial interface</li> <li>Temperature compensation</li> </ul>	UC500-U9 UC3000-U9	500 mm 3000 mm	1NC/1NO	<ul style="list-style-type: none"> <li></li> </ul>	RS232 Serial	ULTRA 3000 DIP Switch
<b>VariKont L2</b> 40 mm x 40 mm x 67 mm 	<ul style="list-style-type: none"> <li>Parameterization interface</li> <li>Basic parameterization using buttons</li> <li>Teach-in</li> <li>Temperature compensation</li> </ul>	UC500-L2 UC2000-L2 UC4000-L2	500 mm 2000 mm 4000 mm	1NC/1NO 2NC/NO	–	<b>PACTware™</b>	Teach-in input Button <b>PACTware™</b>

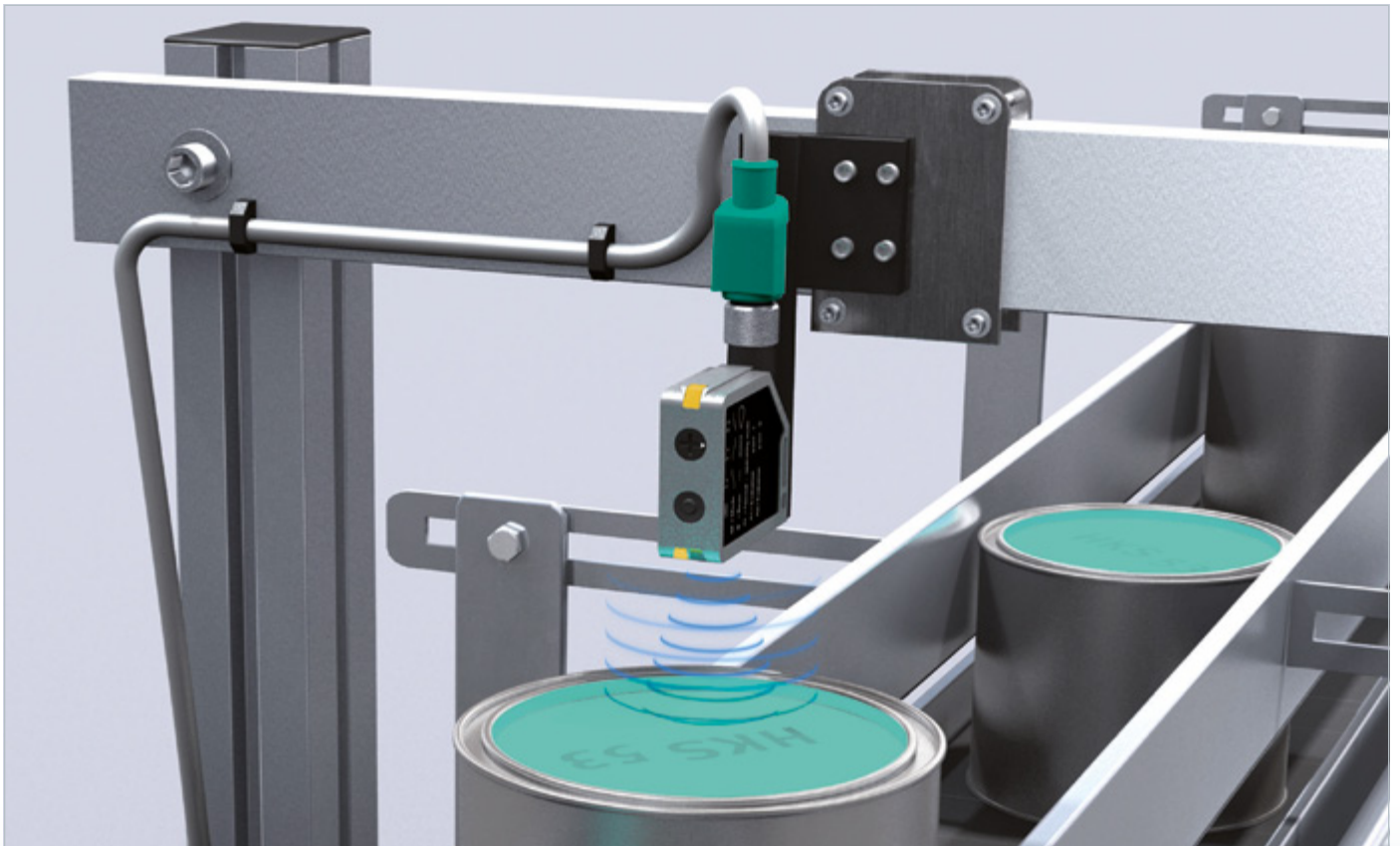

# Special ultrasonic sensors

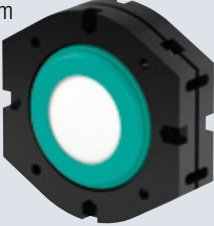
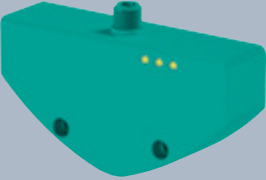
Housing style	Main features	Model number	Sensing range	Switching output	Analog output	Interface	Setting
<b>F260</b> ø 160 mm 	<ul style="list-style-type: none"> <li>Robust design</li> <li>Parameterization interface</li> <li>10 m sensing range</li> <li>Temperature compensation</li> </ul>	UC10000-F260	10000 mm	2NC/2NO	■	Sonprog	Potentiometer
<b>F65</b> 125 mm x 46 mm/64 mm 	<ul style="list-style-type: none"> <li>Suitable for fill level monitoring</li> <li>Parameterization interface</li> <li>Temperature compensation</li> </ul>	UC500-F65 UC1500-F65 UC2500-F65	500 mm 1500 mm 2500 mm	2NO 1NO	Frequency output	Sonprog	Teach-in input

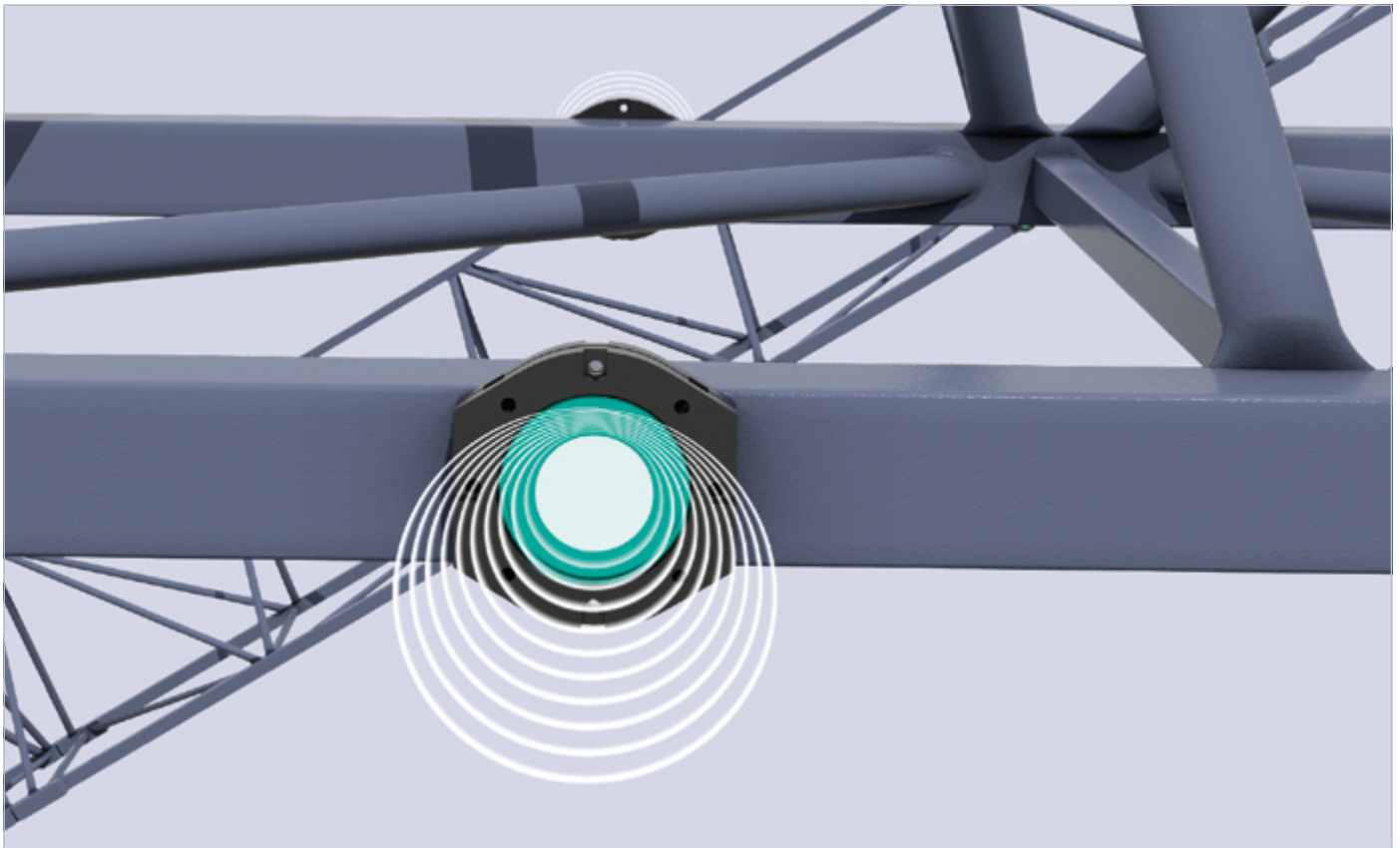

Housing style	Main features	Model number	Sensing range	Switching output	Analog output	Interface	Setting
<b>UMC3000</b> ø 30 mm x 100 mm 	<ul style="list-style-type: none"> <li>Hygienic design</li> <li>Protection class IP68/IP69K</li> <li>Front of converter and housing made from VA4 stainless steel</li> </ul>	UMC3000	3000 mm	1NC/1NO	■	<b>PACTware™</b>	Teach-in input <b>PACTware™</b>
<b>UDC</b> ø 18 mm / ø 30 mm 	<ul style="list-style-type: none"> <li>Double sheet detection</li> <li>No Teach-in required</li> <li>Immune to interference</li> </ul>	UDC-18GM400 UDC-18GMA400 UDC-18GM50 UDC-30GM	–	3NC/NO	–	–	–
<b>UGB</b> ø 18 mm 	<ul style="list-style-type: none"> <li>Adhesive splice monitoring</li> <li>Compact design</li> <li>Very fast processing speeds</li> </ul>	UGB-18GM50	–	2NO	–	–	Teach-in
<b>ULB</b> ø 18 mm 	<ul style="list-style-type: none"> <li>Label monitoring</li> <li>Compact design</li> <li>Very high processing speeds</li> </ul>	ULB-18GM50	–	2NO	–	–	Teach-in

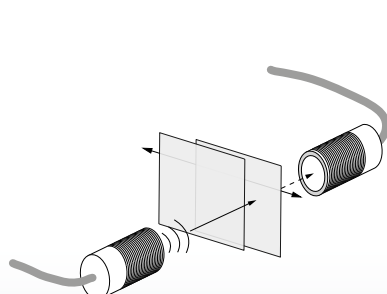

Ultrasonic double sheet control

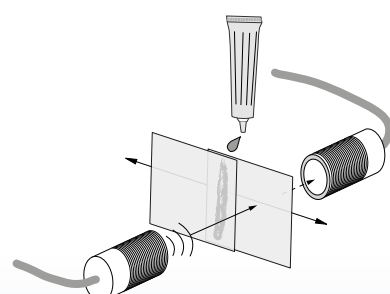

Ultrasonic splice monitoring

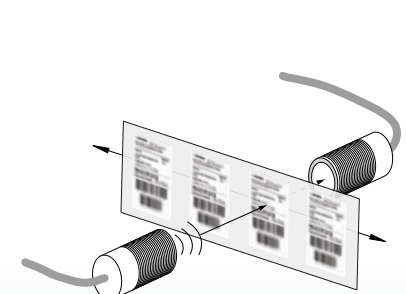

Ultrasonic label monitoring

# Accessories

## MOUNTING ACCESSORIES



MHW04-3505 for FP Series



MH04-2681F for VariKont Series

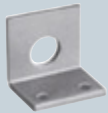

AB12, 18, 30 for all cylindrical sensors with M12, M18, and M30 housing



Mounting aid OMH-4 for ø 18 mm sensors



Mounting aid BF 5-30 for all cylindrical sensors 5 mm to 30 mm in diameter

## MOUNTING BRACKET

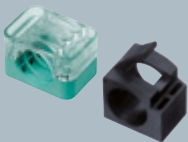

BF30(-F), BF18(-F), BF12(-F)

## FEMALE CORDSETS

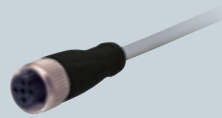

Type G, straight design

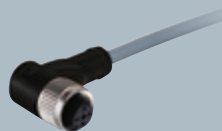

Type W, angled design

See our “Connectors and Splitters” catalog for a more extensive selection of cordsets and extension cables.

## PROGRAMMING UNIT



UB-PROG2



UB-PROG3

## INTERFACE



UC-F43-R2, UC-30GM-R2, UC-FP/U9-R2, UC18/30GM-IR, 3RX400

## DIGITAL DISPLAYS



DA5-IU-C  
DA5-IU-2K-V  
DA5-IU-2K-C

You can find more information about ultrasonic sensor accessories at [www.pepperl-fuchs.com/ultrasonics](http://www.pepperl-fuchs.com/ultrasonics)

# Software

## ULTRA 3000 SERVICE PROGRAM



Ultrasonic sensors with RS232 can also be perfectly adapted to demanding tasks using the ULTRA 3000 service program.

ULTRA 3000 runs on any PC or laptop. Minimum operating requirements include Windows 95/98/ME/NT/2000 or XP, an EGA or VGA graphics card, and an available RS232 interface or USB interface are required if you are using the adapter USB-0.8M-PVC ABG-SUBD9.

Enter the term "ULTRA3000" in the search field on the Pepperl+Fuchs homepage to access information and download the software.

## SONPROG SOFTWARE

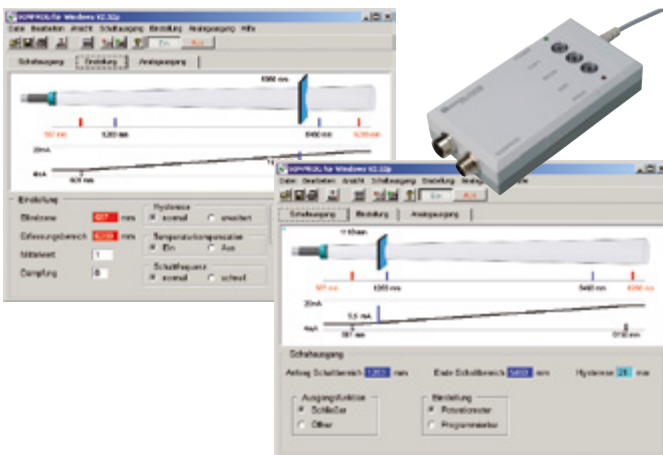

With the 3RX4000 PC interface and the SONPROG software, you can easily adapt the F65 and F260 ultrasonic sensors to the requirements of your specific application.

Enter the term "SONPROG" in the search field on the Pepperl+Fuchs homepage to access information and download the software.

## SOFTWARE PACTware™



PACTware™ is an open, universal operator interface used to parameterize ultrasonic sensors.

Enter the term "PACTware™" in the search field on the Pepperl+Fuchs homepage or visit [www.pactware.com](http://www.pactware.com) to access information and download the software.

## ULTRA-PROG-IR SOFTWARE

Ultrasonic sensors with infrared interface can be adapted easily to the application requirements using the PC program Ultra-Prog-IR and accompanying UC-18/30GM-IR programming adapter.

Enter the term "Ultra-Prog-IR" in the search field on the Pepperl+Fuchs homepage to access information and download the software.

# Staying in Touch. The World Over.

Good customer relationships need care and attention. They are an indication of genuine interest, trust, and a cooperative spirit: the foundation of Pepperl+Fuchs' strengths. No matter where you might be, we are always nearby. And we speak your language – in more than 140 countries the world over.



## At Home on All Continents

Our customers are at the center of all our activities. Our worldwide network ensures that we provide them with the best possible service and support. Our world headquarters in Mannheim services Europe through a network of more than 40 affiliates. Asia is handled by our office in Singapore, with more than 1,000 employees in manufacturing, service, and sales. And our North American headquarters in Twinsburg, Ohio, is responsible for a comprehensive network of offices and sales partners in the USA, Canada, and Mexico.

No matter where in the world you may be, Pepperl+Fuchs is right nearby – and always there for you.

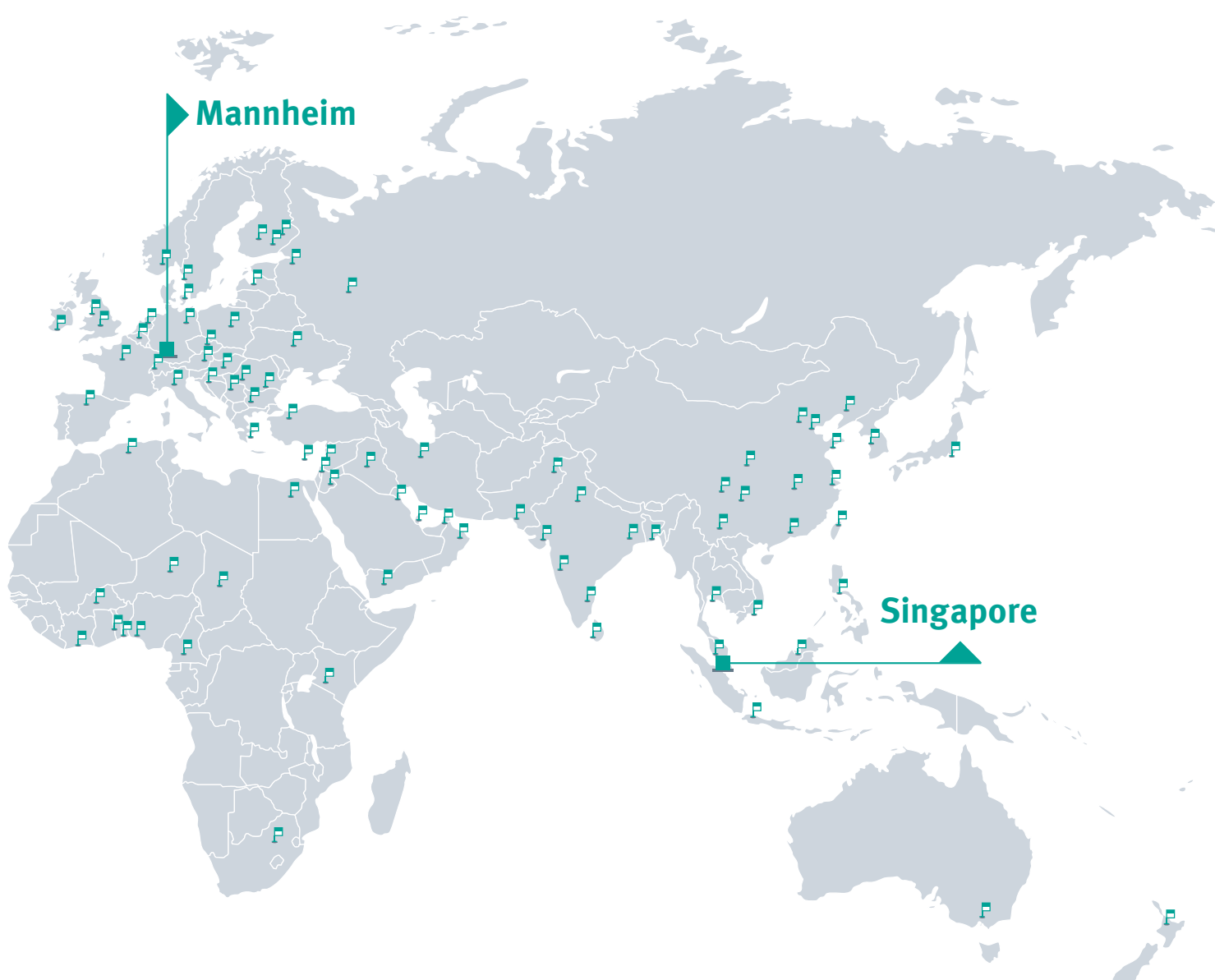

**Mannheim**

**Singapore**



# YOUR APPLICATION. OUR CHALLENGE.

## PROCESS INTERFACES

- Intrinsically safe barriers
- Signal conditioners
- Fieldbus infrastructure
- Remote I/O systems
- HART interface solutions
- Wireless solutions
- Level measurement
- Purge and pressurization systems
- Industrial monitors and HMI solutions
- Explosion protection equipment
- Solutions with process interfaces

## INDUSTRIAL SENSORS

- Proximity sensors
- Photoelectric sensors
- Industrial vision
- Ultrasonic sensors
- Rotary encoders
- Positioning systems
- Inclination and acceleration sensors
- AS-Interface
- Identification systems
- Logic control units

